



## Soil Science and Agricultural Engineering

<http://www.journals.zu.edu.eg/journalDisplay.aspx?JournalId=1&queryType=Master>



## EFFECT OF SOME ENGINEERING PARAMETERS IN THE EGGS INCUBATION OF COMMON CARP (*Cyprinus carpio* Linnaeus)

Mahmoud M. Soliman<sup>1\*</sup>, M.A. Tawfik<sup>2</sup> and M.E. Radwan<sup>1</sup>

1. Cent. Lab. Aquac. Res., Abbassa, Agric. Res. Cent., Egypt

2. Agric. Eng. Dept., Fac. Agric., Zagazig Univ., Egypt

Received: 11/12/2018; Accepted: 14/04/2019

**ABSTRACT:** Common carp is difficult for hatching naturally in the aquaculture ponds due to the deterioration occurred with the natural hatching under environmental conditions, whereas the fry production is less than artificial incubation. So, this study aims to utilize the artificial hatching process to obtain high fertilization and fry production by using two types of incubators the Zug Jar (ZJ) and the ordinary Poultry Drinker (PD). The practical experiments were carried under three water flow rates of 1000, 2100 and 3200 ml/min for 9 liter volume of water and three egg densities per liter of 1000, 2000 and 3000 to determine the hatching ratio and fry production with taking into consideration the water quality indicators including pH, dissolved oxygen and temperature during three days of incubation. The obtained results revealed that the highest value for each of hatching ratio and fry production of  $79 \pm 1.21\%$  as well as  $33 \pm 1.1$  fry/lit for ZJ as well as  $76 \pm 1.23\%$  and  $27 \pm 1.12$  fry/lit for PD, respectively were achieved at the highest water flow rate of 3200 ml/lit and egg density of 3000 egg/lit, but the PD still has the advantage of the low cost comparing to the ZJ, Generally, the both types of incubators consumed large amount of water during incubation period resulting in low fry production and there an urgent need to use a controlled incubator to reduce the wasted water and increase the fry production.

**Key words:** Common carp fish, incubator, poultry drinker, Zug Jar, hatching ratio, fry production.

### INTRODUCTION

Fisheries and aquaculture are remained as an important source of food, nutrition, income and livelihoods for hundreds millions of people around the world. Aquaculture provides half of all fish for human consumption, and to a slight improvement in the state of certain fish stocks due to improved fisheries management. Moreover, fish is considered one of the most-traded food commodities worldwide with more than half of fish exports by value originating in developing countries. Egypt's aquaculture industry come the tenth rank over worldwide and the second in tilapia fish production, behind only China (United States Department of Agriculture, 2016).

Common carp and flathead grey mullet were the first species cultured in the country, where

the common carp being introduced in 1936 for experimental purposes. With the introduction of modern commercial aquaculture in the late 1970s and early 1980s, Egypt built four carp hatcheries and imported brood stock fish from Germany and Hungary (Barrania *et al.*, 1999). Common carps were also extensively used in the government-financed national rice-cum-fish programmes. The total production of carps in 2009 was about 73958 ton or approximately 10.48% of the total aquaculture production, most from poly-culture in rice fields (General Authority for Fish Resources Development, 2010).

Embryos (eggs) of many fish species require incubating and hatching in open water. Eggs are broadcast in the water column and either float or sink; adhesive eggs may attach to plants or hard substrates (rock or gravel). Eggs from other fish

\* Corresponding author: Tel. : +201118764963

E-mail address: mahmoud\_elsaid141@yahoo.com

are laid in a nest, and parent (s) provide a constant water flow by fanning their fins. Some fish also incubate eggs in their mouths where movement of the gill plates provides both gentle tumbling and water circulation. Artificial incubation and hatching of fish embryos simulate these natural processes. In wild, eggs (or egg masses) are susceptible to predation, and are easily damaged by the continual change of the natural environment. The advantage of man-made hatcheries is that the environment can be strictly controlled and manipulated **Craig and Frank (1996)**.

The procedure of injecting tested half a pituitary per kg female spawner one day after transfer into indoor hatchery tanks by which time the fish has acclimatized itself to hatchery conditions. A second injection is given eight hours later with 0.8 pituitary per kg, whilst the males are injected only once a day after transfer to the hatchery with 0.5-0.6 pituitary per kg (**Hepher and Pruginin, 1981**).

Hatchery production confers three main benefits to the industry; out of season production, Genetic improvement and reduce dependence on wild-caught juveniles. Hatchery designs are highly flexible and are tailored to the requirements of site, species produced, geographic location, funding and personal preferences. (**Helm and Bourne, 2004**) Many hatchery facilities are small and coupled to larger on-growing operations, whilst others may produce juveniles solely for sale. Very small-scale hatcheries are often utilized in subsistence farming to supply families or communities particularly in south-east Asia. A small-scale hatchery unit consists of larval rearing tanks, filters, live food production tanks and a flow through water supply (**Sim *et al.*, 2005**). A generalized commercial scale hatchery would contain a broodstock holding and spawning area, feed culture facility, larval culture area, juvenile culture area, pump facilities, laboratory, quarantine area, offices and bathrooms (**Moretti *et al.*, 2005**) The incubator unit is presented for building and inexpensive egg-hatching was poultry drinker which used in chicken farms and available and presented as small scale for hatchery fish. The poultry drinker which used for incubate egg are compared to the zug jars which is used ordinary in hatchery fish.

Hence, the present study aims to induce the breeding of commercially important common

carp (*Cyprinus carpio* Linnaeus) due to the non-availability of its quality seeds from the natural resources for environmental degradation using a simple and cheap incubator represented in the poultry drinker comparing to the conventional incubator of Zug Jar.

## MATERIALS AND METHODS

The practical experiments were carried out at Central Laboratory for Aquaculture Research (CLAR) Abbassa Village, Abou Hammad, Sharkia Governorate, Egypt to evaluate the performance of a modified hatchery egg fish suitable for hatching fish under local conditions.

### Fish Type

Apparently healthy common carp (*Cyprinus carpio* Linnaeus) was used for the artificial spawning and obtaining eggs for incubator unit specimens with an average body weight of 0.8 – 1 kg at 35 – 45 cm of length were obtained from Abbassa fish farm, Abbassa, Abou Hamaad, Sharkia and were acclimated in tank in laboratory condition for two weeks prior the experiment.

### Induction of Spawning

Pituitary gland prepared solution was used for inducing artificial spawning by 3 mg/1 kg of body weight to female, whereas male was injected by 10% of female dose. The spawning was induced after 12 hours from last injection. The eggs were collected from female and mixed with semen fluids of male and treated with the fertilization solution (0.4% sodium chloride, 0.3 urea carbamide), then all eggs were treated with tannin solution to remove any final traces of stickiness.

### The Incubators

Two different types of incubators were used in this study, the first one is the Fiberglass Zug Jar (ZJ) that used to incubate eggs with 9 L volume of water. Its shape divided into two areas the cylindrical top with dimension of 15 cm in diameter and 50 cm in height, while the bottom area has the conical form with dimension of 15 cm in diameter and 25 cm in height as shown in Fig. 1.

The second one is the plastic poultry drinker (PD) that used in chicken farms with 1 L water volume which has a cylindrical shape at the top part with 13 cm in diameter and 11 cm in height while the bottom part is conical with 13 cm in diameter and 4 cm in height, as shown in Fig. 2.



**Fig. 1. Incubation units for Zug jar (ZJ)**

1) Water tank; 2) Zug Jar; 3) Valve; 4) Stand.



**Fig. 2. Poultry drinkers (PD)**

### The Circulating Pump

A centrifugal water pump with 1 hp (0.735 W), Head max 20 m., water flow rate Q max 250 l/min, power was used for streaming the water through the incubated eggs.

### The Contactor and Timer

Contactors are often used in control and regulating functions. The contactor is a magnetic starter device which is designed to provide power to electric motors and providing power-cutoff, under-voltage, and overload protection (Fig. 3).

The function of timer is controlling the intervals between the on and off times of the circulating pump to adjust the operating of the pump at the desirable time.

### The Circuit of pump control

The circuit diagram for controlling the operation of water circulating pump within the incubators can be described as illustrated in Fig. 4.

### Measuring Instruments

#### Dissolved oxygen meter

Water samples from each treatment in this investigation were extracted to determine the concentration of oxygen using the Dissolved Oxygen Meter (YSI Model 58, made of USA), this device can measure the dissolved oxygen in range from 0 to 20 mg/l with resolution of 0.01 mg/l and accuracy of  $\pm 0.03$  mg/l.

#### pH meter

The pH of water within the two types of incubators during the incubation period of common carp eggs were tested using pH meter (JENWAY 3510, made of UK) this device is a digital bench pH meter that can measure the pH from -2.000 to +19.999 with resolution of 0.001, 0.01, 0.1 and accuracy of  $\pm 0.003$ .

#### Digital balances

Two digital balances were used in this study, the first one is digital balance (Model Camry, made of China) with resolution 0.01g and maximum capacity 3000g was used to determine the mass of the common carp eggs and consequently the number of eggs in every gram

after extracting operation from mature fish water tank, and then the intensity of the eggs can be adjusted in every liter of water in the incubator. The second one is a digital balance with resolution 50 g and maximum capacity 10Kg was used also for weighting the male and female fish before the pituitary injection process to determine the injection dose.

### The Microscope

Since the extracted eggs from the mature fish tanks contain unfertilized eggs, hence an ordinary microscope [Theory: (Biological Microscope), Drawtube: (Binocular), Achromatic Objectives (4X, 10X, 40X (S), 100X (S, Oil)), Eyepiece: (Wide Field Eyepiece, WF10X (WF16X optional))], Viewing head: (Sliding Binocular Head Inclined at 45°), Stage:(Double Layer Mechanical Stage Size 140X 140 mm, Moving Range 75X45 mm), Condenser: (Abbe NA=1.25 with Iris Diaphragm and Filter), Illumination: (Halogen Lamp 220V/6V20).] was used to determine the fertilized eggs before incubation. This device was used for checking embryonic development in eggs samples during incubation period to calculate the hatching ratio at the end of incubation period.

### Methodology

In this study, the artificial incubation of common carp (*Cyprinus carpio* Linnaeus) eggs and water quality were investigated under different operational parameters as follows:

- 1-Two types of incubator The Zug Jar (ZJ) and Poultry Drinker (PD).
- 2-Three water flow rates of 1000, 2100 and 3200 ml/min.
- 3-Three different densities of fertilized eggs of 1000, 2000 and 3000 egg/l.

Hence, the total numbers of the treatments in this study were 18 treatments which had implemented in 3 replicates each through three different incubation periods.

### Water quality

Water samples from each treatment were tested to determine the concentration of pH, dissolved oxygen, and temperature.

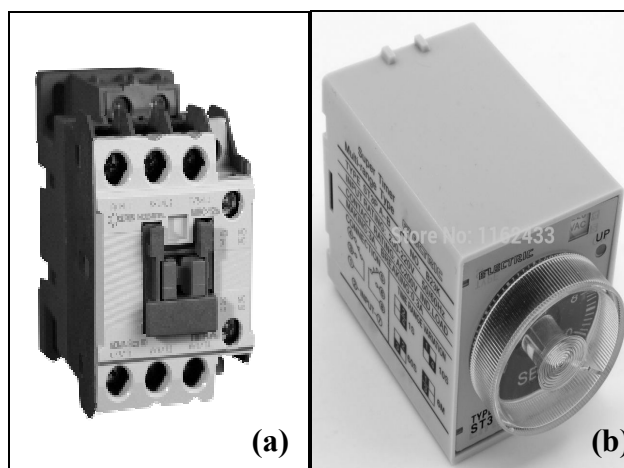

Fig. 3. a) Contactor and b) Timer

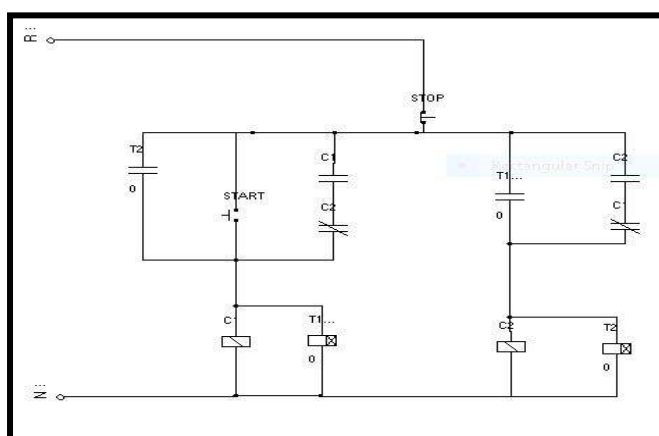

Fig. 4. Control circuit

Symbol	Description
Stop	Push button normally close
Start	Push button normally open
C1	Contact No.1
C2	Contact No.2
T1	Timer No.1
T2	Time No.2
R	Electric line
N	Neutral line

### The common carp eggs

Swollen eggs of the common carp were used at different densities to investigate the previous parameters. Eggs were collected from aquarium after 12 hr., from fish laying eggs in water and one gram of eggs was take and counted separately. During the incubation period, the number of eggs was assessed in several times to observing their developing embryonic. Manual counting and weighing are used then the average mass of each fry was calculated.

### Hatching ratio (HR)

Glass of water was used to collect and count fries from each incubator by naked eye (Gapasin and Marte, 1990) for calculating the

hatching ratio. Hatching ratio has to be monitored carefully and dead eggs were counted and noted during incubation. The hatching ratio (HR) was calculated using the following relation:

Hatching ratio (%) = amount of fry/amount of fertilized eggs

### Fry production

It can be defined as the number of fries per unit volume of water or in other words the amount of using water during the incubation period. Fry production is considered an important indicator for the water consumption during incubation and can be determined as follows:

Fry production (fry/l) = [amount of fry/(water flow rate, l/min × time of incubation, min)]

## RESULTS AND DISCUSSION

The obtained results will be discussed under the following topics:

### Water Quality

pH was measured by pH meter every 2 hours as depicted in Fig. 5. It was varied from 3.25 in the third day at time 10 PM. to 7.55 in the second day at time 2 PM.

Oxygen concentration was measured by oxygen meter every 2 hours (Fig. 6). It was varied from 4.1 mg/l in the first day at time 2 AM to 6.1 mg/l in the third day of incubation period at time 2 PM.

Temperature degree was measured by oxygen meter every 2 hrs., (Fig. 7). It was varied from 19°C in the third day at time 2 AM to 23.2°C at time 2 PM.

Water quality monitor during the incubation period for observe any change in water parameters (pH, oxygen concentration, and temperature degrees). pH was varied from 3.25 in the third day at time 10 P.M. to 7.55 in the second day at time 2 P.M pH levels can fluctuate daily due to photosynthesis and respiration in the water. Oxygen concentration was varied from 4.1 mg/l in the first day at time 2 A.M. to 6.1 mg/l in the third day at time 2 P.M, oxygen solubility is lower in warmer water. This may be a consequence of cooling water discharge on surface waters due to fluctuate of temperature which was varied from 19°C in the third day at time 2 AM to 23.2°C at time 2 PM that was agree with results of *Ali et al. (1993)* during evaluation of water quality and nutritional status of aquaculture effluent in Saudi Arabia.

### Hatching Ratio

Fig. 8 illustrates that the effect of water flow rate and density of fertilized eggs in ZJ on hatching ratio at the end of incubation period that extended to three consecutive days. The obtained results showed that the hatching ratio was about 69, 69 and 74% for eggs density of 1000, 2000, and 3000 egg/l in ZJ, respectively at water flow rate 1000 ml/min, Also, the hatching rate was 70, 71 and 75% for eggs density of 1000, 2000 and 3000 egg/l in ZJ, respectively at water flow rate of 2100 ml/min and 70, 75 and 79% at

water flow rate, 3200 ml/min. Generally, there is no significant difference in hatching ratio at the low egg density under all water flow rates but a clear difference was significantly appeared at the high egg density of 3000 egg/l, where the increase of egg density from 1000 to 3000 egg/l led to increase the hatching ratio with about 6.75% and 11.38% at water flow rate of 1000 and 3200 ml/min., respectively, hence the highest hatching ratio was achieved at the highest egg density and water flow rate. It is obvious that the increase of water flow rate at the high egg density means renewing the water continuously within the incubator and preventing the sudden collapse of the oxygen concentration resulting in a good increment in the hatching ratio. Furthermore, increasing the water flow rate can give good flipping for eggs that can be led to boost the chances of eggs to obtain the optimum amounts of oxygen. These results are in agreement with *Jeffery et al. (1995)* who found that egg cultured in hatching jars at 1200 ml/min flow were lifted into the water column and rolled moderately, this flow rate significantly increased the present hatch due to the control of fungus, while the eggs in hatching jars at 300 and 600ml/min flow rate exhibited no egg movement and reduced hatching success.

On the other hand, the effect of water flow rate and density of eggs in PD on hatching ratio is depicted in Fig. 9. The obtained results revealed the same trend previously observed, where the hatching ratio was about 54, 64 and 70 % for eggs density of 1000, 2000 and 3000 egg/l in PD, respectively at water flow rate 1000 ml/min, while it was 55, 70 and 74% at water flow rate of 2100 ml/min., as well as 57, 71 and 76% at water flow rate 3200 ml/min. for eggs density of 1000, 2000 and 3000 egg/l. It is clear that using the low egg density of 1000 egg/l in PD is not preferable because it gave hatching ratio with about 21.74, 21.42 and 18.57 % lower than the ZJ at water flow rate 1000, 2100 and 3200 ml/min, respectively. Regarding the geometry shape of the incubator, the hatching ratios in ZJ was higher than the PD incubator and this can be attributed to the conical shape of the ZJ that gave good flipping for the eggs with slowing down the water steam within the incubator which led to prevent the eggs impact with the incubator's inner wall and consequently more alive embryos can be obtained. From economic

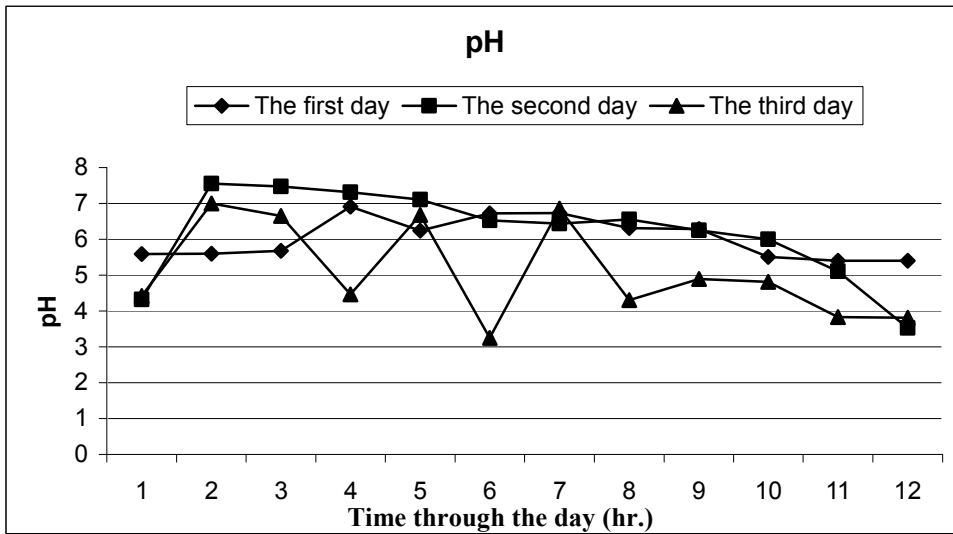

Fig. 5. pH, during the incubation period

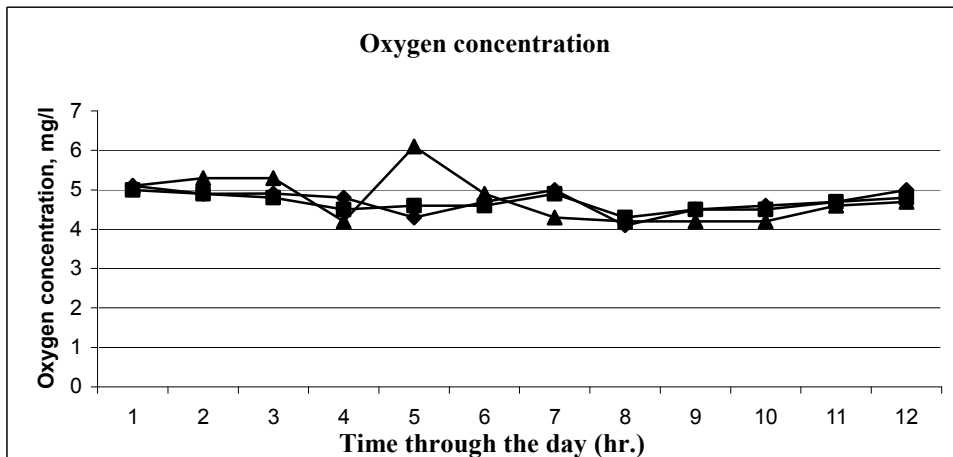

Fig. 6. Oxygen concentration during the incubation period

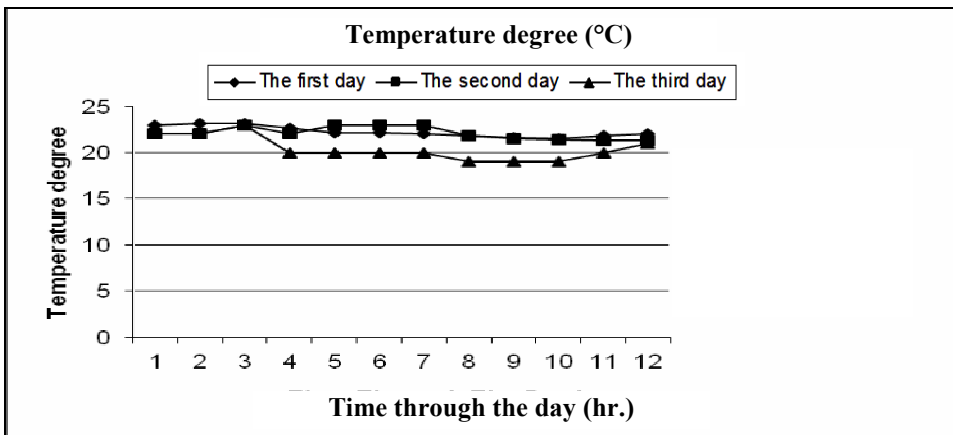

Fig. 7. Temperature degrees during the incubation period

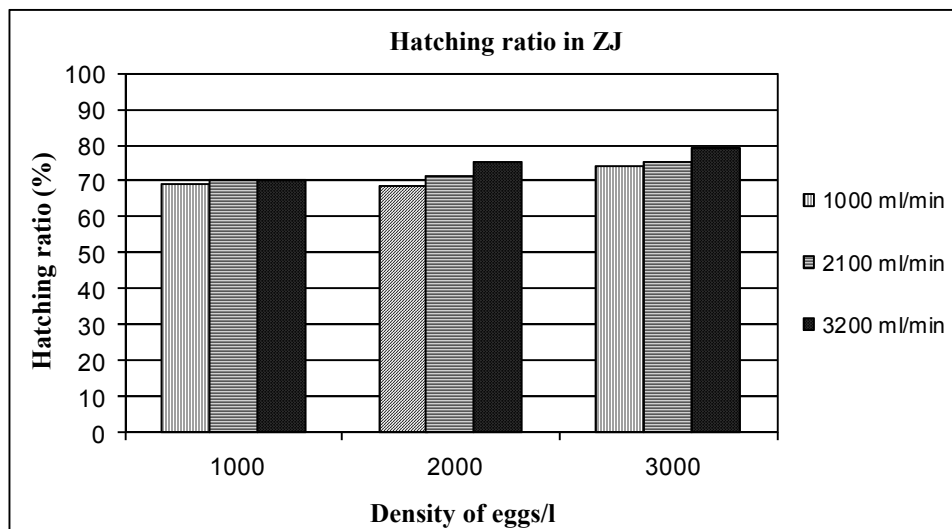

Fig. 8. Effect of water flow rate and density of eggs on hatching ratio in ZJ

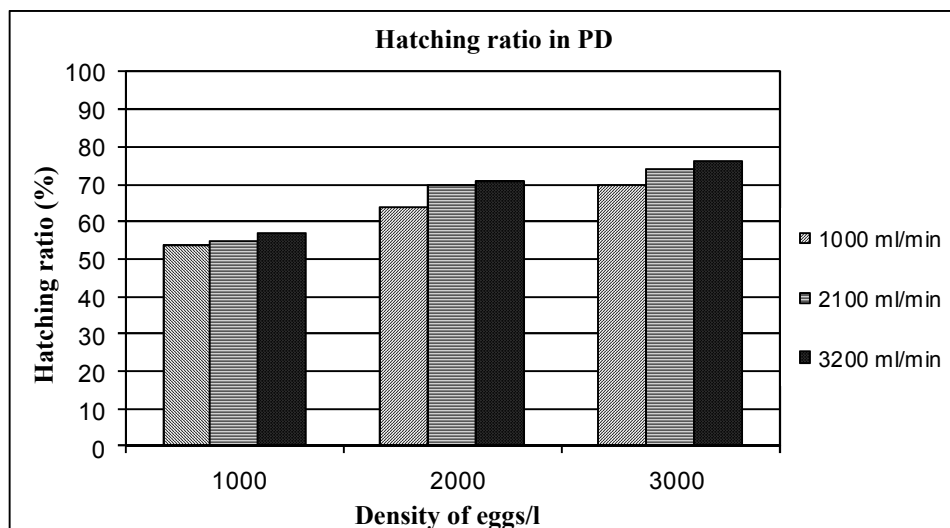

Fig. 9. Effect of water flow rate and density of eggs on hatching ratio in PD

point of view, the difference in hatching ratio between the ZJ and PD not exceeded about 3.80% at highest egg density of 3000 egg/l and water flow rate of 3200 ml/min, so the PD incubator can be selected as an economic option due to its simplicity and low price, particularly at high density of eggs and water flow rate.

### Fry Production

The fry production is the number of fry per the unit of water volume, in other words it is an important indicator for efficiency of using water during the incubation period. Concerning to the incubation of common carp eggs in ZJ, Fig.10

depicts the effect of density of eggs and water flow rate on fry production after three days of incubation. The obtained results showed that the consumed water at the end of incubation period for ZJ was about 5040 L corresponding to fry production of 8, 11 and 22 fry/l for eggs density of 1000, 2000, and 3000 eggs/l, respectively using flow rate 1000 ml/min. Moreover, the consumed water at the highest flow rate of 3200 ml/min were 16128 L corresponding to fry production of 12, 17 and 33 fry/l for eggs density of 1000, 2000, and 3000 eggs/l, respectively. At constant water flow rate, the fry production increased by increasing the density



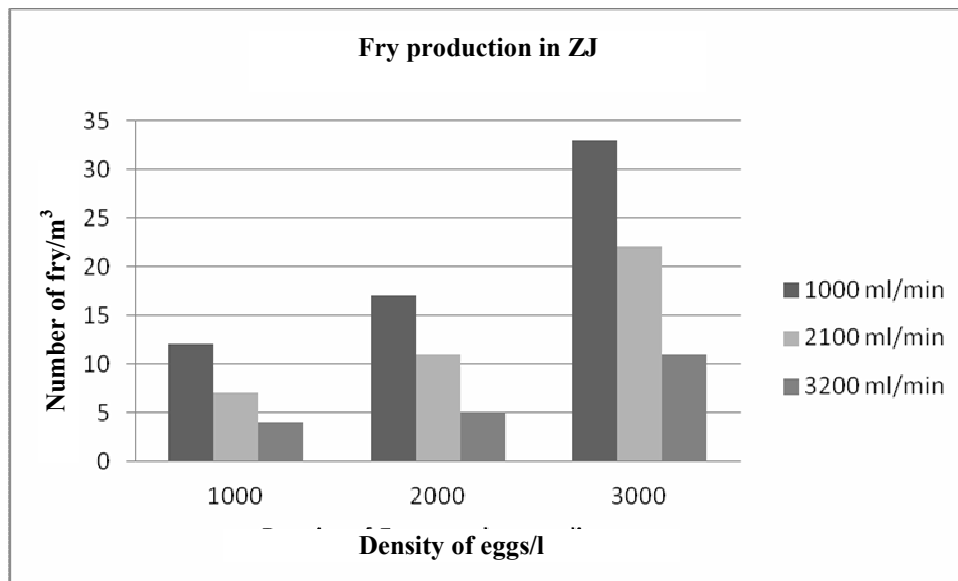
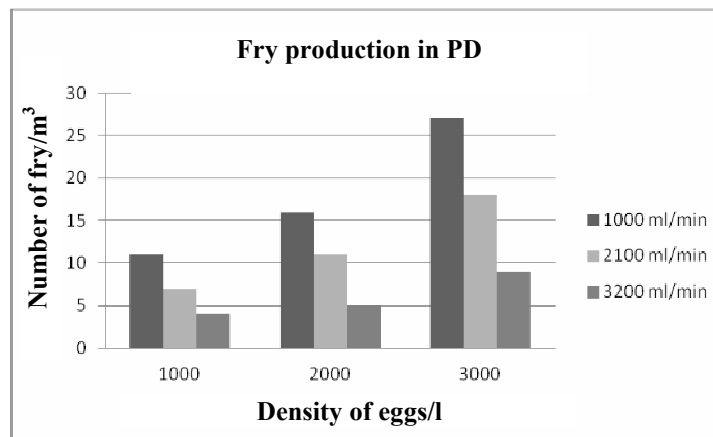

**Fig. 10. Effect of water flow rate and density of eggs on number of fry per the unit of water volume in ZJ**

of eggs due to the increase of hatching ratio and the constant amount of using water, whereas the fry production increased by increasing the water flow rate from 1000 to 3200 ml/min. This can be attributed to the remarkable increment that occurred in the amount of hatched eggs compared to the increase of water flow rate, whereas the increase of amount of fry reduce the negative effect of the increase of water flow rate on the fry production. These results are in agreement with those of the **Valetta et al. (2016)** indicated that there is potential to increase *Oreochromis karongae* fry production by manipulating water flow rates and egg population density combinations during incubations. Regarding the PD, the effect of water flow rate and density of eggs within PD on fry production is shown in Fig. 11, which depicts the effect of density of eggs and water flow rate on fry production after three days of incubation. The obtained results showed that the consumed water at the end of incubation period for PD were about 5040 L corresponding to fry production of 4, 5, and 9 fry/l for eggs density of 1000, 2000, and 3000 eggs/l, respectively using flow rate of 1000 ml/min. Additionally, the consumed water at the highest flow rate of 3200 ml/min were about 16128 L corresponding to fry production of 11, 16 and 27 fry/l for eggs density of 1000,

2000 and 3000 eggs/l, respectively. The same trend was observed, where at constant water flow rate, the fry production increased by increasing the density of eggs due to the increase of hatching ratio and the constant amount of using water, whereas the fry production increased by increasing the water flow rate from 1000 to 3200 ml/min. This could be attributed due to the increase of amount of fry is higher than the increase of water flow rate at constant incubation time.

It is obvious that the fry production in ZJ was higher than the PD due to the remarkable increment in the hatching ratio in ZJ comparing to the PD. According to the previous discussion, the best results for the hatching ratio and fry production, particularly at high water flow rate and eggs density were achieved by using the ZJ, but the PD still has the advantage of the low cost comparing to the ZJ. Generally, the both types of incubators consumed large amount of water during incubation period resulting in low fry production, hence there is an urgent need to fabricate a simple incubator, with strict control for the operation parameters such as; water temperature provided with water recirculation option to reduce the wasted water during incubation and consequently increasing the fry production.



**Fig. 11.** Effect of water flow rate and density of eggs on number of fry per unit of water volume in PD

### Conclusion

The best results for the hatching ratio and fry production, particularly at high water flow rate and eggs density were achieved by using the ZJ than using PD, but the PD still has the advantage of the low cost comparing to the ZJ. Generally, the both types of incubators consumed large amount of water during incubation period resulting in low fry production, hence there is an urgent need to use a more controlled incubator to reduce the wasted water and increase the fry production.

### REFERENCES

- Ali, A.A, S. Abdul-Qayyum and H. Ghulam (1993). Evaluation of water quality and nutritional status of aquaculture effluent in Saudi Arabia. Proc. Aquac. Symposium. Technol. and Invest. Opportunities. Riyadh, Saudi Arabia, 160-172.
- Barrania, A., R. Rackowe, J. Gleason, S. Hussein and M. Abdelaal (1999). Identifying Policy Barriers for Fisheries Development, Agric. Policy Reform Program, Minist. Agric. and Land Reclamation, Report No. 76.
- Craig, A.W. and Frank A.C. (1996). Artificial Incubation of Fish eggs Institute of food and Agricultural Sciences, University of Florida Extension.
- Gapasin, R.S.J. and C.L. Marte (1990). Milkfish hatchery operations. Tigbauan, Iloilo, Philippines: SEAFDEC Aquac. Dept.
- General Authority for Fish Resources Development (GAFRD) (2010). Statistics of fish production of year 2009. Cairo, Egypt, GAFRD, Minist. Agric. and Land Reclamation, 104.
- Helm, M.M. and N. Bourne (2004). Hatchery culture of bivalves A practical manual. FAO FISHERIES TECHNICAL PAPER 471.
- Hepher, B. and Y. Pruginin (1981). Commercial Fish Farming with Special References to Fish Culture in Israel. John Wiley and Sons. NY. 261.
- Jeffery, J., R. Jennifer and K. Verdef (1995). Effect of water flow rates in hatching jars to control fungal infections of Rainbow Trout eggs. The Progressive Fish Culturist, 57 (3): 515-526.
- Moretti, A., M.P. Fernandez-Criado and R. Vetillart (2005). Manual on Hatchery Production of Seabass and Gilthead Seabream. Rome, FAO, 2: 152.
- Sim, S.Y., M.A. Rimmer, J.D. Toledo, K. Sugama, I. Rumengan, K.C. Williams, M.J. Phillips (2005). A Practical Guide to Feeds and Feed Management for Cultured Groupers. NACA, Bangkok, Thailand, 18.
- United States Department of Agriculture (2016). The state and development of aquaculture in Egypt. Gain Report. Global Agric. Inform. Network.
- Valeta, J., J. Likongwe, D. Kassan, A. Mluwa and H. Zidani (2016). Effect of incubation water flow nad egg population density on hatching success of *Oreochromns karongae*, Fifth Ruforum. Regional Conf. 17-21 October. Cape Twon. South. Africa, 14: 2.

## تأثير بعض العوامل الهندسية على تحضين بيض المبروك العادي

محمود محمد السعيد سليمان<sup>١</sup> - محمد على توفيق<sup>٢</sup> - محمد السيد اسماعيل<sup>١</sup>

١- المعمل المركزى لبحوث الثروة السمكية بالعباسة- مركز البحوث الزراعية - مصر

٢- قسم الهندسة الزراعية- كلية الزراعة - جامعة الزقازيق - مصر

التفريخ الطبيعي لأسماك المبروك العادي من الصعوبة حدوثه في أحواض الإستزراع السمكي نتيجة للتدهور الذي يحدث أثناء التفريخ تحت الظروف البيئية الطبيعية حيث أن إنتاجية الزريعة أقل بكثير من تلك الناتجة عن التفريخ الصناعي، لذلك تهدف هذه الدراسة إلى استغلال عملية التفريخ الصناعي للحصول على أعلى تخصيب وإنتاجية للزريعة باستخدام نوعين من الحضانات وهما الزوجار وسقاية الدواجن التقليدية، أجريت التجارب العملية باستخدام ثلاثة معدلات من سريان المياه وهي ١٠٠٠، ٢١٠٠، ٣٢٠٠ لتر/دقيقة مع ثلاثة كثافات بيض وهي ١٠٠٠، ٢٠٠٠، ٣٠٠٠ بيضة/لتر لتحديد نسبة الفقس وإنتاجية الزريعة مع الأخذ في الإعتبار مؤشرات جودة المياه و التي تشمل رقم الحموضة والأكسجين المذاب ودرجة الحرارة أثناء ثلاثة أيام من التحضين، أوضحت النتائج المتحصل عليها أن أعلى نسبة للفقس وإنتاجية الزريعة كانت ٧٩% و ٣٣ زريعة/لتر في الزوجار بينما كانت الفقس ٧٦% و ٢٧ زريعة/لتر في سقاية الدواجن علي الترتيب والتي تحققت عند أعلى معدل سريان مياه وهو ٣٢٠٠ لتر/دقيقة وكثافة بيض ٣٠٠٠ بيضة/لتر، ولكن تبقي سقاية الدواجن الإختيار الاقتصادي بالمقارنة بالزوجار، بصفة عامة فإن كلا النوعين من الحضانات يستهلك كميات كبيرة من المياه أثناء فترة التحضين وبالتالي إنتاجية زريعة أقل، لذلك هناك حاجة ماسة لحضان يعمل على عدم إهدار المياه أثناء التحضين ومن ثم زيادة إنتاجية الزريعة.

المحكمون:

١- د. عادل شـالبي

٢- أ.د. أسامة محمد عبدالمنعم

رئيس بحوث الثروة السمكية - مركز البحوث الزراعية بالعباسة.  
أستاذ الإنتاج الحيواني وعميد كلية الزراعة - جامعة الزقازيق.